

**SERVICE MANUAL  
FOR**

**handic SI-99**  
Selective-call module  
CCIR/ZVEI

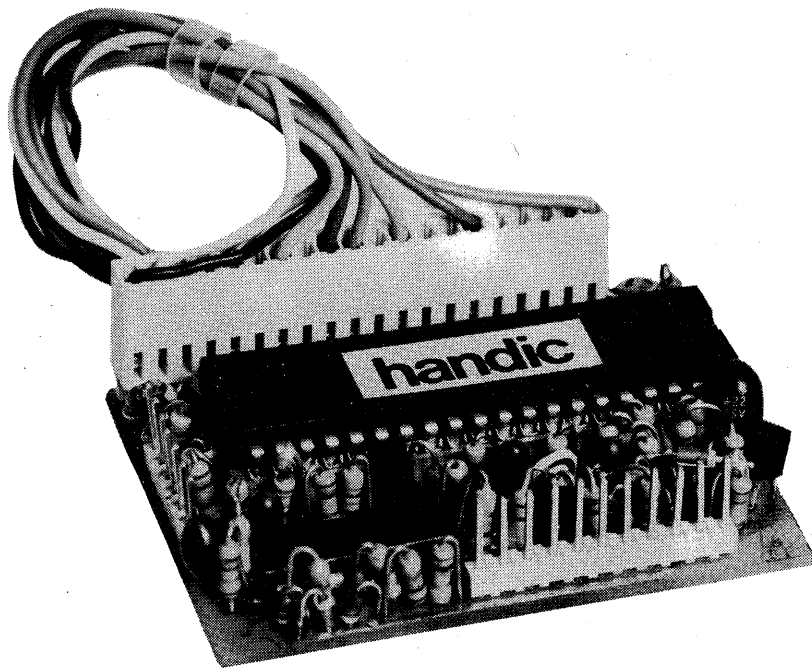

**handic**  
**electronic ab**

Box 1063, S-436 00 Askim/Gothenburg, Sweden  
Telephone: 031/28 97 90      Telex: 21420

— A company in the Datatronic group —

# EXTERNAL CONNECTIONS

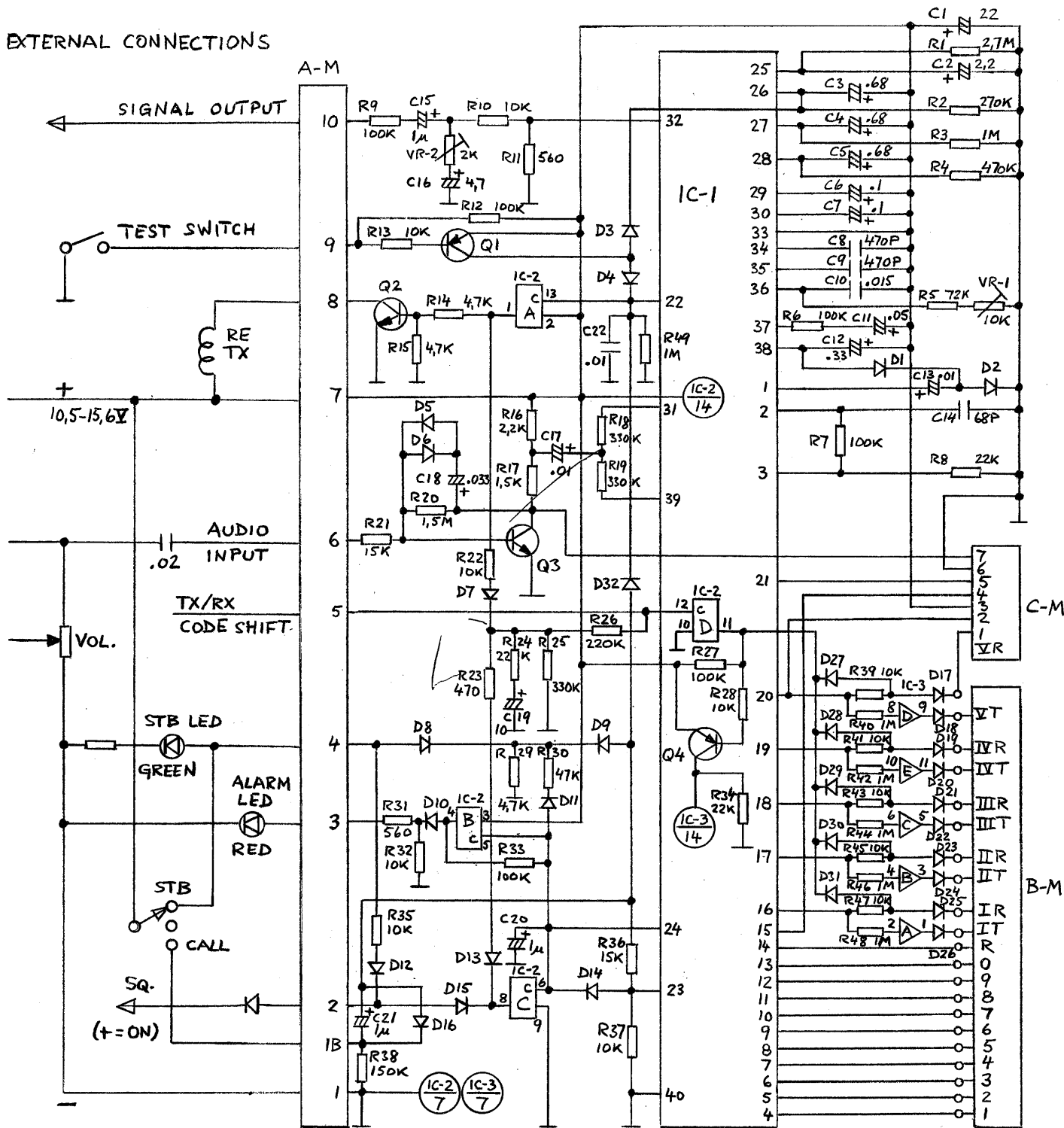

## DESCRIPTION

The SI-99 selective-call module is based on a monolithic MOS-LSI (IC-1) that produces the five different tone frequencies of the CCIR (or ZVEI) seletcall system. SI-99 operates on 10.5-15.6 V, basically in the following way:

The pins 1-3, 25-30, and 33-38 of the LSI, and all components connected to these pins (in the upper right corner of the schematic diagram) determine the reset time (pin 25), tone length (26), TX delay (27), gate period (28), tone frequency (36), etc.

LSI pins 4-21 are used to code the different tone frequencies.

LSI pin 22 will start the transmission of the tones, if connected to plus. A call is started by a plus pulse through pin 1B of connector A-M and capacitor C21. Pin 22 will stay plus during the transmission cycle, and is therefore used to key the transmitter relay through gate A of IC-2 and through Q2.

If a call is started by the test switch, A-M pin 9 is continuously connected to ground, and transmission will start, but as LSI pin 26 is connected to plus, the first tone will be kept

until the test switch is released.

The audio for modulation will come out on LSI pin 32. It is put through a filter connected to A-M pin 10. If the audio is too low for the transceiver in use, VR-2 should be adjusted (also, R9 may be decreased or even shorted).

In receive mode, the signal is fed through A-M pin 6 and Q3 (the latter working as a compressor amplifier) to LSI pins 31 and 39. The amplified signal can be checked at C-M pin 7.

If a call is detected, LSI pin 23 will become plus (pin 24 in case of a group call). This will alert the alarm LED, fed through gate B of IC-2, and cancel the squelch blocking, since gate C will be opened. If the seletcall switch of the transceiver is in STB position, the five receive tones will be transponded (except in case of group calls, which do not alert the transponding facility). After transponding, gates B and C will remain open until the seletcall switch is set to OFF.

After a call (except when transponding), the transmit code is

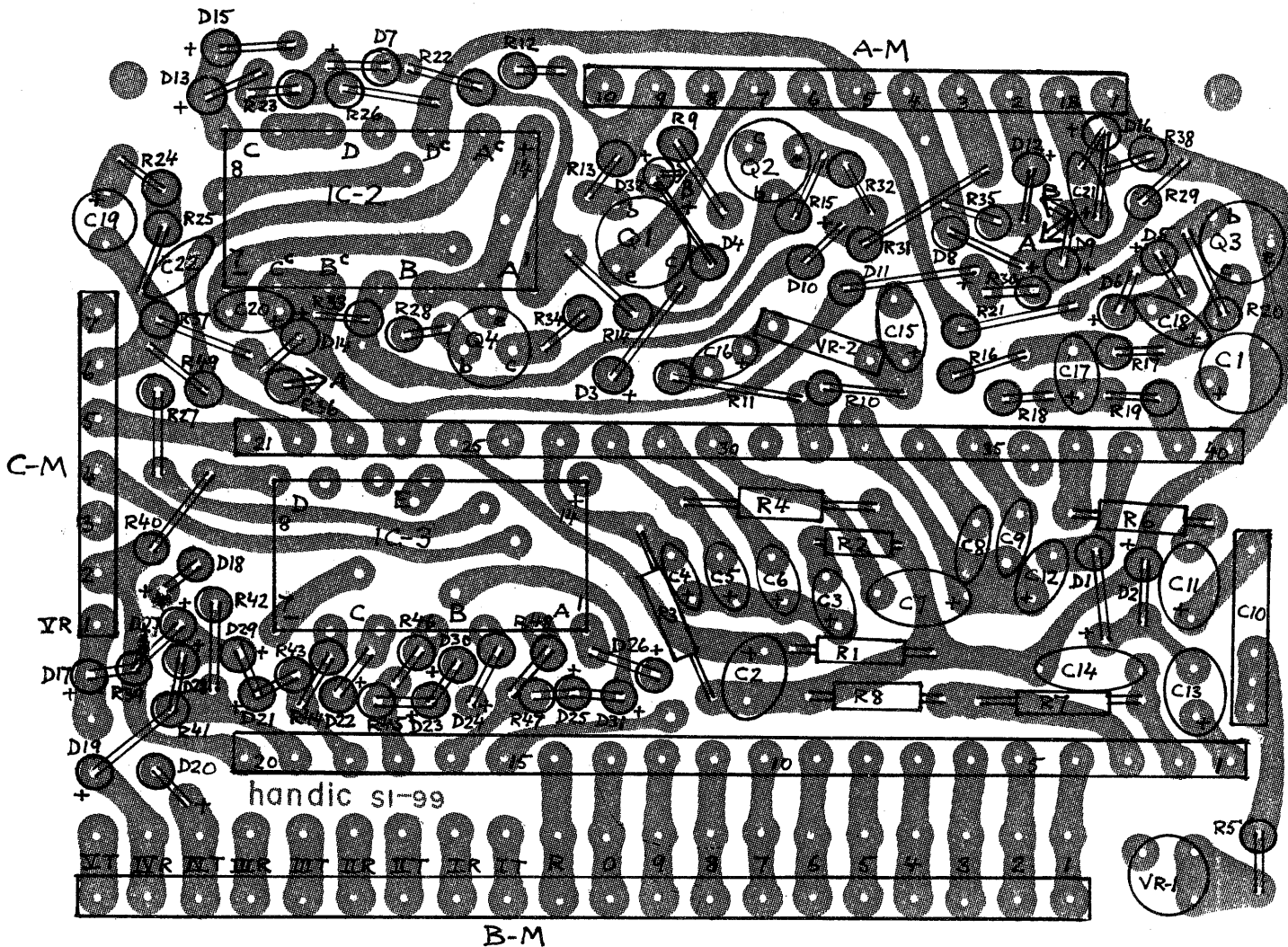

used as receive code for about 2 seconds (since R22-26 and C19 keep the controller of IC-2 gate D to plus). During this period no transponding is possible - since the selecall switch is not in STB position, R29 prevents the voltage of LSI pin 22 to be high enough to start a transmission. LSI pin 23 will stay plus for approx. 4 seconds, and the alarm LED will also be lighting during this time.

The voltage at the controller of IC-2 gate D determines whether the module works in transmit or receive mode. When transmitting a call (not transponding), it is plus, grounding through IC-2 gate D all receiving connections from LSI pins 16-20 and activating IC-3 by giving current through Q4. In receive or transpond mode, IC-2 is closed, and so are Q4 and IC-3.

**ADJUSTMENT**

Connect the module to plus (A-M pin 7) and minus (A-M pin 1) and to frequency counter (A-M pin 10). Connect B-M pin IT to pin 6 to get tone No. 6. Connect A-M pin 9 continuously to ground, and read the frequency. Adjust VR-1 to 1541 Hz (CCIR) or 1666 Hz (ZVEI).

Adjust VR-2 to get the desired modulation.

**MALFUNCTIONS**

If the SI-99 does not work properly, first check all connections of A-M, B-M, and C-M to be clean and free from dirt and dust. Also check that the LSI has been correctly inserted and all pins connected.

If the module still does not work properly, the malfunction is probably located in the components (or component connections) around the LSI (the malfunctions very seldom occur in the IC).

**Transmitter:**

The transmitter does not start: Check that LSI pin 22 is minus before a call and gets a plus pulse when the selecall switch is moved to the CALL position. Otherwise, check R38, C21, D16, D32, and R49. Also, check IC-2.

The LSI works (pin 22 is plus for about one second), but the

TX relay does not switch: Check that IC-2 gate A gives plus to base of Q2, and if so, check Q2.

The LSI and the TX relay work, but there is no modulation: Check the components between LSI pin 32 and A-M pin 10. Also, check that the output at A-M pin 10 has not been shorted by microphone or other connection. If some, but not all tones come through, check the coding connections on LSI pins 4-20. Also, check that there is plus from B-M pins IT to VT.

**Receiver:**

Check the signal input at A-M pin 6 and the amplified signal from Q3 (the collector is connected to C-M pin 7). An input signal of more than 10 mV rms should be amplified and seen as a square wave from Q3. An increase of the signal should have no effect, since Q3 works as a compressor amplifier.

Check detection of the first tone at LSI pin 16. If the first tone is fed continuously, pin 16 shall switch from plus to minus and back to plus approx. 5 times per second (since the second tone is not detected, the LSI is reset after approx. 200 ms).

Transmit the complete call and check that all B-M pins IR to VR go to plus. If not, check IC-3, all components in the coding section, Q4, and gate D of IC-2. If the coding section works properly, check LSI pin 23 and IC-2 gates C and D.

Frequency drift: The frequency is determined by C10 and by R5 and VR-1. It is recommended to seal these three components by means of silicon spray after every repair, and also before using a SI-99 for the first time, in order to prevent frequency drift caused by humidity.

Checking IC-2 and IC-3: When checking the IC's, be careful not to short-circuit any of the pins, as this may damage the IC.

**IC-2 pin voltages:**

Mode	Pin 1	2	3	4	5	6	7	8	9	10	11	12	13	14
Call	12	12	0	0	0	0	12	0	0	12	12	12	12	12
RX STB	0	12	12	0	0	0	2-10	0	0	12	0	0	12	12
RX alarm	0	12	12	12	8	8	0	0	0	12	0	0	12	12

IC-3: Apply plus to A-M pin 5 and check the voltage at pin 14 to be 12 V. Check gate outputs 1, 3, 5, 9, and 11 to be 12 V, if the corresponding inputs are fed with 12 V.

handic

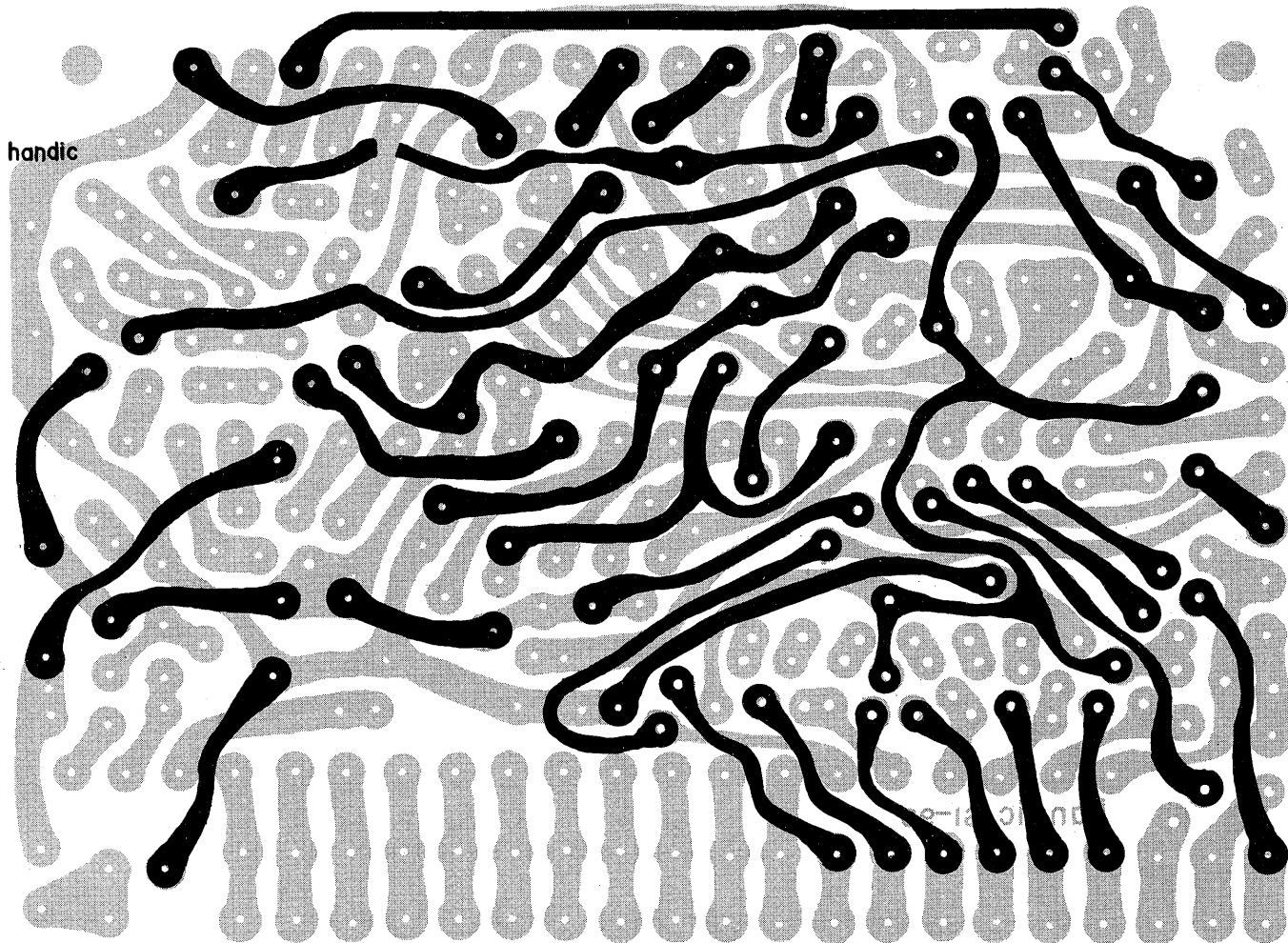

**PARTS LIST**

Item	Pcs.	Item	Pcs.	Item	Pcs.
PC board	1	0,33 uF: C12	1	10 K: R35, R37, R39, R41, R43, R45, R47	12
Integrated circuits:		0,1 uF: C6, C7	2	4,7 K: R14, R15, R29	3
LSI: IC-1	1	0,05 uF: C11	1	2,2 K: R16	1
CD4016CN: IC-2	1	0,033 uF: C18	1	1,5 K: R17	1
MM74C907N: IC-3	1	0,01 uF: C13, C17	2	560 ohms: R11	1
Socket for IC-1 (Molex 1988-04-20)	1	Capacitor, metal film:		470 ohms: R23	1
Transistors:		0,015 uF: C10	1	Resistor, metal film, 1/8 W:	
KSA 733 (BC 328): Q1, Q4	2	Resistor, carbon, 1/4 W:		72 K: R5	1
KSD 471 (BC 338): Q2	1	560 ohms: R31	1	Variable resistors:	
KSC 184 (BC 547): Q3	1	Resistors, carbon, 1/8 W:		10 K: VR-1	1
Diodes:		2,7 M: R1	1	2 K: VR-2	1
1S1555: D1 - D32	32	1,5 M: R20	1	Molex connectors:	
Capacitors, ceramic:		1 M: R3, R40, R42, R44, R46, R48, R49	7	3022-11A, 11-pin male: A-M	1
0,01 uF: C22	1	470 K: R4	1	3022-20A, 20-pin male: B-M	1
470 pF: C8, C9	2	330 K: R18, R19, R25	3	3022-07A, 7-pin male: C-M	1
68 pF: C14	1	270 K: R2	1	3180-20, 20-pin female connector cabinet	1
Capacitors, tantal:		220 K: R26	1	Wires, 70 mm, with crimp terminal:	
22 uF: C1	1	150 K: R38	1	1 each brown, red, orange, yellow, green, blue, purple, grey, white, black	10
10 uF: C19	1	100 K: R6, R7, R9, R12, R27, R33	6		
4,7 uF: C16	1	47 K: R30	1		
2,2 uF: C2	1	22 K: R8, R24, R34	3		
1 uF: C15, C20, C21	3	15 K: R21, R36	2		
0,68 uF: C3, C4, C5	3	10 K: R10, R13, R22, R28, R32,			
(0,47 uF: C3, C5 in ZVEI version)	2)				

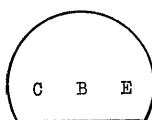

KSA 733

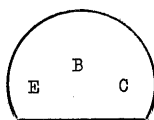

BC 328

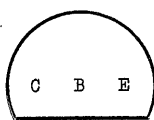

KSD 471

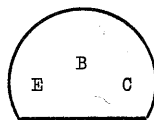

BC 338

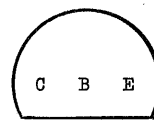

KSC 184

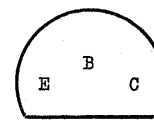

BC 547

Frequency system	Tone No.	1	2	3	4	5	6	7	8	9	0	R	G
CCIR	(Hz)	1121	1200	1278	1357	1444	1541	1638	1747	1856	1983	2113	2401
ZVEI	(Hz)	1058	1163	1269	1402	1530	1666	1828	2001	2203	2403	2601	2796